

“Comparative analysis of two conceptual frameworks to measure creativity at a university”

AUTHORS

Ziska Fields, Christo Bisschoff

ARTICLE INFO

Ziska Fields and Christo Bisschoff (2014). Comparative analysis of two conceptual frameworks to measure creativity at a university. *Problems and Perspectives in Management*, 12(3)

JOURNAL

"Problems and Perspectives in Management "



NUMBER OF REFERENCES

0



NUMBER OF FIGURES

0



NUMBER OF TABLES

0

© The author(s) 2017. This publication is an open access article.

Ziska Fields (South Africa), Christo Bisschoff (South Africa)

Comparative analysis of two conceptual frameworks to measure creativity at a university

Abstract

Creativity is often misunderstood due to inconsistencies concerning the definition of creativity, the methodologies used to explain creativity as a phenomenon and the various measurement instruments to determine creative ability. This article aimed to compare two conceptual frameworks to identify the most reliable and valid conceptual framework to measure creativity at a university. The findings showed that both conceptual frameworks are different in their own right and both are valid and reliable. Only marginal differences could be observed from the statistical tests used in the comparative analysis. The uniqueness and value of the paper lies in the validation of these conceptual frameworks to measure creativity.

Keywords: creativity models, creativity measurement instruments, factors, comparative analysis, pure factors, Pearson correlations, variance explained.

JEL Classification: I20.

Introduction

Groenewald (2013, p. 18) states that “every facet of our existence depends to an increasing extent on utilising people’s creative ability”. Creativity is the process of generating a variety of novel ideas by combining convergent and divergent thinking aimed to solve problems, identify unique opportunities or to develop new products or services, which are critical to human progress and survival (Allen, 2012, p. 47; Barringer & Ireland, 2010, pp. 79, 85). Over the years, researchers tried to understand and explain how creative thinking occurs and how creative ideas emerge. This led to the creation of more than 450 definitions of creativity (Groenewald, 2013, p. 20), various creativity models (for example Wallas’ creativity process model (1929), Parnes, Isaksen and Trefflinger’s CPS model (1985, 1992) and Plsek directed creativity cycle model (1996); and the development of a variety of creativity tests (for example Taylor’s creative product inventory (1975), Torrance’s tests of creative thinking (TTCT) (1966), Sternberg’s triarchic abilities test (1997)). The TTCT is the best-known of the tests based on divergent thinking (Cropley, 2008, p. 4; Bronson & Merryman, 2011, p. 21). The variety of approaches and definitions seems to make creativity as a concept challenging to fully comprehend and measure. Measuring creativity has however remained problematic due to the fact that a number of instruments were developed without being scientifically tested for reliability and validity. The British company Mycotod, which is an educational body that promotes creativity and innovation in students, for example, listed one-hundred-and-eighty-three creative-thinking methods in alphabetical order (Lau, Ng & Lee, 2009,

p. 72). The challenge is to find the most suitable technique and to use a technique that has been tested to ensure success.

Two conceptual frameworks were developed to measure creativity. Twenty five models and tests (Table 1 below) were identified from literature to develop the two conceptual frameworks.

Table 1. Creativity models and tests

Year	Researcher/s	Model
1926	Graham Wallas seen as the pioneer in creativity research	Wallas model for the process of creativity
1931	Rossman	Rossman’s creativity model
1950	Joy Paul Guilford	Guilford’s concept of divergent thinking
1953	Alex Osborn	Seven-step model to creative thinking
1961	Mel Rhodes	Four P’s to creativity
1966	Ellis Paul Torrance	Torrance tests of creative thinking (TTCT)
1981	Kolberg and Bagnall	Kolberg and Bagnall’s universal traveller model
1983	Amabile	Amabile’s model
1985	Bandrowski	Model for creative strategic planning
1985, 1992	Parnes, Isaksen and Trefflinger	Creative problem-solving (CPS) model
1988	Barron	Barron psychic creation model
1989	Kirton	Adaptors versus innovators
1991	Fritz	Model for the process for creation
1995-1996	Sternberg & Lubart	Sternberg & Lubart’s systems orientated model
1996	Plsek	Directed creativity cycle
1996, 1999	Csikszentmihalyi	Csikszentmihalyi’ model
2000	Min Basadur	Creative problem solving profile (CPSP) inventory, also called the ‘New Mental Model’
2001	Unsworth	Unsworth’s model of creativity tasks
2002	Florida	Florida’s creativity index
2003	Mark Runco	Parsimonious creativity model (Based on Rhodes’ 4 P’s)
2003	Luecke and Katz’s	Luecke and Katz’s innovation model
2005	Park & Jang	Cognitive motives

© Ziska Fields, Christo Bisschoff, 2014.

The article stems from PhD studies at the North-West University, Potchefstroom, RSA by Ziska Fields

Table 1 (cont.). Creativity models and tests

Year	Researcher/s	Model
2005	Ruth Byrne	Rational imagination
2005	John Baer & James Kaufman	Amusement part theoretical (APT) model of creativity
2009	Collaboration with Jack Chung, Shelley Evenson and Paul Pangaro	A model of the creative process

Source: Fields Z., Bisschoff C.A., 2013a.

One conceptual framework was developed to measure creativity in a general setting amongst young adults and another conceptual framework was developed to measure creativity in a tertiary educational setting. Both frameworks were tested for reliability and validity.

The focus of this article is to determine the most reliable and valid conceptual framework to measure creativity and a comparative analysis approach was used. The approach was used to compare the two conceptual frameworks in terms of the factors identified in each, to determine how strong the identified factors correlate, to determine how much these conceptual frameworks differ from one another, to determine the variance and the reliability of these factors and to determine the 'goodness of fit' of the respective conceptual frameworks.

1. Objectives

The primary objective of this paper was to compare the *general framework to measure creativity* (CF1) against an applied *measuring framework for tertiary education* (CF2) in order to determine which of the two frameworks best suit the measurement of creativity. This primary objective was achieved through the following secondary objectives:

- ◆ provide an overview of each one of the two conceptual frameworks;
- ◆ compare the empirical results of the two frameworks using a number of statistical criteria;
- ◆ recommend the most suitable conceptual framework to measure creativity.

2. Comparative criteria

The two conceptual frameworks were compared by using the following statistical results:

- ◆ factor comparison of factors identified by the two frameworks (CF1 and CF2);
- ◆ factor correlation coefficients;
- ◆ variance explained by the factors;
- ◆ points of inflection of the factors;
- ◆ reliability of the factors within the studies;
- ◆ determine the goodness of fit of the respective conceptual frameworks (CF1 and CF2).

3. Factor analysis

Factor analysis is not a single statistical method, but represents a complex range of structure-analyzing procedures which are used to identify the interrelationship among a large set of observed variables. These variables are then reduced through data reduction to a small set of factors that have common characteristics (Nunnally & Bernstein, 1994 in Pett, Lackey and Sullivan, 2003, p. 2; Field, 2007, p. 666; Rasool, 2012). Factor analysis can be used to assess the reliability and validity of measurement scales according to Carmines & Zeller (1979 in Albright & Myoung Park, 2009, p. 2; Hafiz & Shaari, 2013, p. 86), which makes this valuable to the objectives of this study.

There are two basic types of factor analysis, namely exploratory factor analysis (EFA) and confirmatory factor analysis (CFA) (Albright & Myoung Park, 2009, p. 2; Suhr, p. 1). Exploratory factor analysis (EFA) was used in this paper and is used when the number of factors that are necessary to explain the interrelationships among a set of variable are not known, and the underlying dimensions of the construct being researched need to be determined. Harrington (2008, p. 1) describes confirmatory factor analysis (CFA) as a multivariate statistical procedure that is used to test how well the measured variables represent the number of constructs. CFA was not used in this paper because the aim of the study was to determine the latent constructs underlying a set of variables, to identify factors and to define the meaning and content of these factors to create a conceptual framework to measure creativity.

An exploratory factor analysis (EFA) consists of different steps. Albright and Myoung Park (2009, p. 10) identify three key steps:

- ◆ the creation of a correlation matrix;
- ◆ extraction of factors using a principle factor (PL), maximum likelihood (ML), weighted least squares (WLS) or generalized least squares (GLS) for example;
- ◆ rotation of the extracted factors to foster interpretability by maximizing factor loadings close to 1.0 and minimizing factor loadings close to 0.

De Coster (1998, p. 1) identifies eight basic EFA steps when an exploratory factor analysis is conducted and these steps were followed in this paper. These steps are:

- ◆ step 1: collect measurements;
- ◆ step 2: obtain the correlation matrix;
- ◆ step 3: select the number of factors for inclusion;
- ◆ step 4: extract the initial set of factors;

- ◆ step 5: rotate factors;
- ◆ step 6: interpret the factor structure;
- ◆ step 7: construct factor scores for further analysis.

Factor analysis has proven to be an effective method to use in this paper.

3.1. Pearson's correlation coefficient. Field (2007, p. 791) describes Pearson's correlation coefficient as a standardized measure of the strength of relationship between two variables. The Pearson correlation coefficient has the ability to determine the differences in two factors' pattern of loadings and indicate the differences (or similarities) in the magnitude of these loadings, even if dissimilarities exist in the factor loadings (Du Plessis, 2010, p. 121). Pearson's correlation coefficient is regarded as a satisfactory correlation measure (Wuensch, 2009, pp. 13-14) which makes it valuable in the comparative analysis of two creativity measurement models. The cut-off correlation for this paper was determined to be an absolute Pearson correlation coefficient of 0.30, signifying a medium relationship or correlation between variables (Du Plessis, 2010; Zikmund, 2008, p. 551).

3.2. Cumulative variance explained. Variance indicates the dispersion of scores around the mean and is basically the average error between the mean and the observations made. Variance shows how well a model fits the actual data (Field, 2002, p. 6). The variance explained was used in this paper to compare the strength of the factors in each model, then to identify pure, common and specific factors, to determine the goodness-of-fit of each model (Hafiz & Shaari, 2013, p. 84) and to determine the point of inflection (Rasool, 2012, p. 79). Variance played an important role in interpreting various aspects and completing various steps in the factor analysis process, as well as in comparing the two creativity measurement models. The data was required to explain a cumulative variance of in excess of 60%. A cumulative variance in excess of 60% signifies a "good fit" as stated by Field (2007, p. 668; Hafiz & Shaari, 2013, p. 84).

3.3. The points of inflection. The point of inflection was used in this paper to compare the two models because it displays the distribution of variance explained by the factors. If the variance explained via the point of inflection shows that variance patterns reach the point of inflection, it will mean that factors could be omitted from the analysis (Schönrock-Adema et al., 2009, p. 228). If more variance is explained earlier by a model it means that that model is a more suitable choice as measuring framework (Rasool, 2012, p. 79).

3.4. Reliability of the factors (Cronbach alpha). Validity and reliability are fundamental elements in

the evaluation of a measurement instrument and therefore very important in this article. An instrument cannot be valid unless it is reliable, however the reliability of an instrument does not depend on its validity. Cronbach coefficient alpha (α) is the most widely used measure of reliability (Tavakol & Dennick, 2011, pp. 53-54). Cronbach alpha was used in this paper to compare the reliability of the factors of the two models and to determine which of the two models was more reliable to measure creativity. According to Suhr (p. 2), in support of Tavakol & Dennick (2010, p. 54) the model with the higher reliability coefficient normally provides a more consistent measurement. An acceptable level of reliability for the study was set as 0.7. A secondary lower limit of 0.58 was also employed in lower reliability cases because interval data was used in this study (as suggested by the seminal work on reliability by Cortina (1993, p. 101)).

3.5. Kaiser, Meyer and Olkin (KMO) analysis and the Bartlett test of sphericity. The Kaiser-Meyer-Olkin (KMO) measure is used to measure the sampling adequacy and to examine the appropriateness of factor analysis based on the sample characteristics (Bama, 2013). KMO, according to Schwarz (2011, p. 25), has become the standard test procedure for factor analysis. The KMO measure was used in this study to compare the two models and to determine which model's sample was more adequate and which model was more appropriate for using factor analysis. Values of 0.70 and higher (as suggested by Bama, 2013; Field, 2007) was set as the minimum required KMO value for sampling adequacy in this study.

The Bartlett test of sphericity renders a verdict on the suitability of the data to be used in multivariate statistical techniques (such as factor analysis) (Bama, 2013), and favorable values (sufficient for factor analysis) are those that are below the 0.005 level (Du Plessis, 2009, p. 58). Bartlett's test of sphericity was used in this paper to compare the two models and to determine which model was best suited for factor analysis. If the correlations among the variables are too low, the model will not be appropriate. The maximum value for this study was set 0.005 (Field, 2007, p. 668; Bama, 2013).

4. Creativity measurement models

Two models were developed to measure creativity. The first model (CF1) is a general framework to measure creativity (Fields & Bisschoff, 2013a) and the second model (CF2) is an applied measuring framework for tertiary education (Fields & Bisschoff, 2013b).

4.1. Model 1 (CF1). This model is a general framework to measure creativity and consists of nine factors. The model is illustrated in Figure 1.

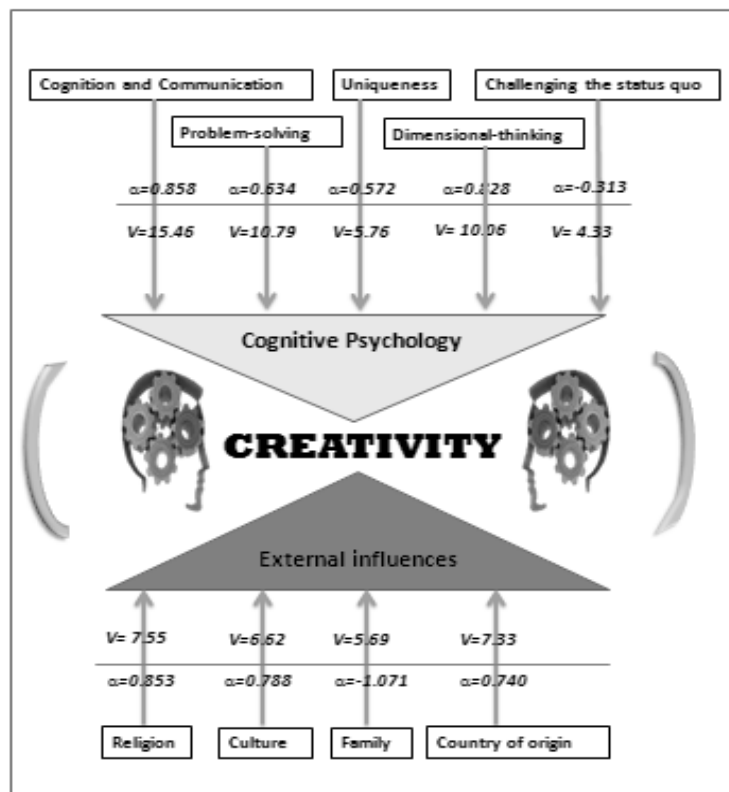

Source: Fields Z., Bisschoff C.A., 2013a.

Fig. 1. Model 1 (CF1)

The model illustrates the nine factors and the variance per factor. According to this model (CF1), nine factors need to be measured to determine creativity in a general setting. These factors are:

- ◆ Factor 1, *Cognition and Communication*, is the most important factor with a favorable variance of 15.46%. This factor indicates that it is very important to consider and find different links and relationships when looking at a variety of information sources, as well as the ability to cope with complexities, the motivation to tear down barriers to creative thinking and the ability to use communication effectively to reveal creative ideas to others and to persuade others that these ideas are valuable. Cronbach's coefficient alpha (α) is 0.858 and shows a very satisfactory reliability coefficient well in excess of the required 0.70 for this factor.
- ◆ Factor 2, *Problem-solving*, is the second most important factor to consider when one is measuring creativity in a general setting. This factor explains a favorable variance of 10.79% and points to the ability to produce solutions to problems by looking at a variety of solutions in a novel way, solving problems in a short period of time and using experimentation to find the best creative solution. Cronbach's coefficient alpha (α) is 0.634 which is marginally below the upper limit of 0.70 and above the lower limit of 0.57 and therefore can be seen as satisfactory.
- ◆ Factor 3, *Dimensional Thinking*, explains a favorable variance of 10.06% and points to the ability to look for similarity in concepts, processes and patterns to find creative ideas, and the ability to consider the dimensionality of an issue in terms of space. Cronbach's coefficient alpha (α) is 0.828 and shows a very satisfactory reliability coefficient.
- ◆ Factor 4, *Religion*, points specifically to the impact religion has on an individual's creative output and creative thinking and explains a favorable variance of 7.55%. Cronbach's coefficient alpha (α) is 0.853 and shows a very satisfactory reliability coefficient.
- ◆ Factor 5, *Country of origin*, points to the impact the country of origin has on beliefs, values and self-expression and its impact on the creative thinking of people living in a certain country. This factor explains a favorable variance of 7.33%. Cronbach's coefficient alpha (α) is 0.740 and shows a satisfactory reliability coefficient.
- ◆ Factor 6, *Culture*, explains a variance of 6.62% and points to the impact of society and community on people's creativity in a general setting. Cronbach's coefficient alpha (α) is 0.788 and shows a very satisfactory reliability coefficient.
- ◆ Factor 7, *Uniqueness*, points to the ability to find solutions or generate ideas by looking at the uniqueness in features and processes and to separate objects to find creative solutions. The

factor explains a variance of 5.76%. Cronbach's coefficient alpha (α) is 0.572 and shows an acceptable reliability coefficient as it is slightly above the lower limit.

- ◆ Factor 8, *Family*, points to the role of family members to encourage and value creativity while growing up and explains a variance of 5.69%. Cronbach's coefficient alpha (α) is -1.071 and shows a negative reliability coefficient (signifying failing reliability of the factor) and care should be taken as this factor is less likely to represent itself in repetitive studies.
- ◆ Factor 9, *Challenging the status quo*, points to the need to intentionally engage in unpopular ideas and explains a variance of 4.33%. Cronbach's coefficient alpha (α) is -0.313 and shows a negative reliability coefficient and care

should be taken as this factor is less likely to represent itself in repetitive studies.

These factors can be grouped into two groups:

- ◆ Factors 1, 2, 3, 7, 9 fall into the cognitive psychology group.
- ◆ Factors 4, 5, 6, 8 fall into the external influences group.
- ◆ No personality characteristics were specifically identified during the data analysis and exploratory factor analysis stages. External influences appeared to have a much greater impact on creativity in a general setting than personality characteristics.

4.2. Model 2 (CF2). This model is an applied measuring framework for tertiary education and consists of twelve factors. This model is illustrated in Figure 2.

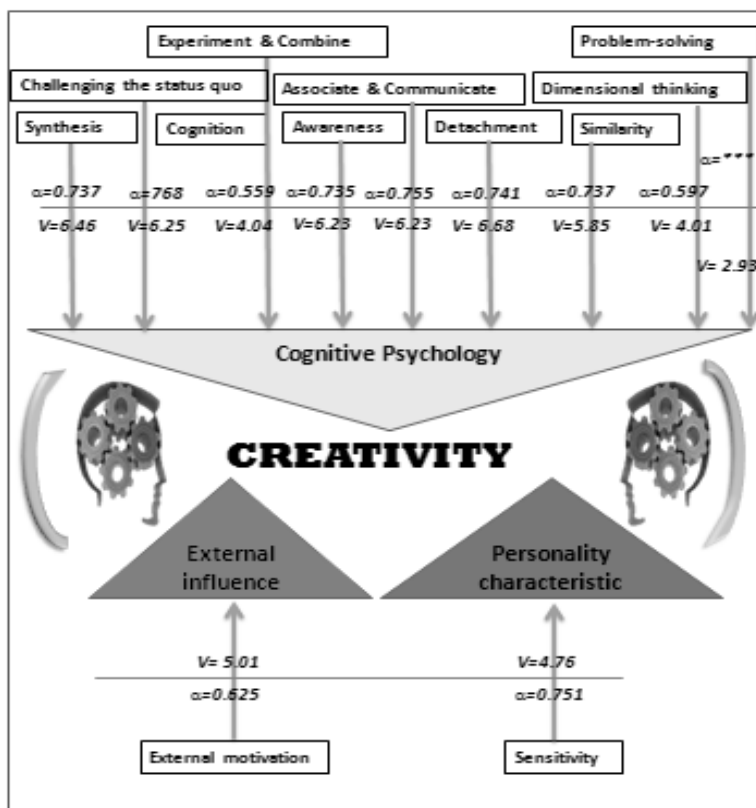

Source: Fields Z., Bisschoff C.A., 2013b.

Fig. 2. Model 2 (CF2)

The model illustrates the twelve factors and the variance per factor. According to this model (CF2), twelve factors need to be measured to determine creativity for tertiary education. These factors are:

- ◆ Factor 1, *Challenging the status quo*, is the most important factor with a favorable variance of 7.72%. This factor points to an individual's willingness and motivation to challenge assumptions, to take initiative, to look at the big picture, being creative in an environment that tears down personal barriers to creative thinking

and being motivated to be creative in his/her own interest areas. Cronbach's coefficient alpha (α) is 0.753 and shows a satisfactory reliability coefficient.

- ◆ Factor 2, *Detachment*, is the second most important factor and explains a variance of 6.68%. Factor 2 points to the ability to separate processes, resources, objects and dimensions in an effort to be creative. Cronbach's coefficient alpha (α) is 0.741 and shows a satisfactory reliability coefficient.

- ◆ Factor 3, *Synthesis*, is the third most important factor and explains a variance of 6.46%. This factor points to the ability to combine processes and to look for uniqueness and similarity in processes to help find solutions or generate ideas, as well as the ability to combine concepts to find creative solutions. Cronbach's coefficient alpha (α) is 0.737 and shows a satisfactory reliability coefficient.
- ◆ Factor 4, *Cognition*, points to the ability to discover links and relationships by looking for a different and a variety of information sources, as well as the ability to cope with complexities when a problem needs to be solved. This factor explains a favorable variance of 6.25%. Cronbach's coefficient alpha (α) is 0.768 and shows a satisfactory reliability coefficient.
- ◆ Factor 5, *Associate and Communicate*, points to the ability to generate new ideas by looking actively for associations among concepts, the use of brainstorming to make associations, to propose new ideas regularly and the ability to persuade others that creative ideas generated are valuable. This factor explains a favorable variance of 6.23%. Cronbach's coefficient alpha (α) is 0.755 and shows a satisfactory reliability coefficient.
- ◆ Factor 6, *Awareness*, points to the ability to recognize gaps and contradictions in existing knowledge, to see different aspects of a problem and the ability to not get stuck on a set of rules to solve a problem. This factor also explains a variance of 6.23%. Cronbach's coefficient alpha (α) is 0.735 and shows a satisfactory reliability coefficient.
- ◆ Factor 7, *Similarity*, explains a variance of 5.85% and points to the ability to look for similarities in problems, solutions, patterns and concepts. Cronbach's coefficient alpha (α) is 0.737 and shows a satisfactory reliability coefficient.
- ◆ Factor 8, *External motivation*, points to the impact of external pressures and people to solve problems and to intentionally engage in unpopular ideas. This factor explains a variance of 5.01%. Cronbach's coefficient alpha (α) is 0.625 which is marginally below the upper limit of 0.70 and above the lower limit of 0.57 and therefore can be seen as satisfactory.
- ◆ Factor 9, *Sensitivity*, points to the sensitivity of a person to various aspects of a problem. This factor explains a variance of 4.76%. Cronbach's coefficient alpha (α) is 0.751 and shows a satisfactory reliability coefficient.
- ◆ Factor 10, *Experiment and Combine*, points to the ability to find the best creative solution by experimenting and combining objects. This factor

explains a variance of 4.04%. Cronbach's coefficient alpha (α) is 0.559 which is marginally lower than the lower limit of 0.58 set by Cortina (1993), and therefore, this factor might not present itself in repeated research.

- ◆ Factor 11, *Dimensional Thinking*, points to the ability to consider the dimensionality of an issue to create ideas in terms of cost and time. The factor explains a variance of 4.01%. Cronbach's coefficient alpha (α) is 0.597 and shows an acceptable reliability coefficient slightly above the lower limit of 0.570.
- ◆ Factor 12, *Problem-solving*, points to random attempts to solve a difficult problem. The factor explains a variance of 2.93%. Cronbach's coefficient alpha (α) could not be calculated for this factor and this factor might therefore not be present in repeated studies.

These factors can be grouped into three groups:

- ◆ Factors 1, 2, 3, 4, 5, 6, 7, 10, 11, 12 fall into the cognitive psychology group. Tertiary education requires more cognitive processes therefore this is not surprising that more cognitive psychology factors were identified in the model.
- ◆ Factor 8 falls into the external influences group. Motivation can be seen as a cognitive psychology influence as well, but the model focuses on external motivation specifically and therefore the impact of the external environment on the creativity needs to be considered and measured.
- ◆ Factor 9 falls into the personality characteristics group.

Both models have merit. It is important however to determine the most reliable and valid model to measure creativity as part of this study. Before this can be done however, the criteria for the comparative analysis need to be clarified.

5. Research methodology

The primary objective of this paper was to compare the general framework to measure creativity (CF1) against an applied measuring framework for tertiary education (CF2) in order to determine which of the two frameworks best suit the measurement of creativity.

The comparative analysis used in this study followed the following steps:

- ◆ step 1: comparing the identified factors and Pearson's correlation coefficient between the common factors;
- ◆ step 2: comparing the cumulative variance explained by the factors and determining and comparing the goodness of fit measures for each model;

- ◆ step 3: comparing the points of inflection in the factors;
- ◆ step 4: comparing the reliability of the factors (Cronbach Alpha);
- ◆ step 5: comparing the Kaiser, Meyer and Olkin (KMO) analysis and the Bartlett test of sphericity.

The results of the comparative analysis are discussed below.

6. Results

6.1. Factor comparison. As part of this comparative study, a factor comparison was done and the identified factors are shown in Table 2 below.

Table 2. Factors identified

Factor no.	Conceptual framework (CF1)		Conceptual framework (CF2)	
	Factor label	% variance exp	Factor label	% variance exp
1	Cognition and communication	15.46%	Challenging the status quo	7.72%
2	Problem-solving	10.79%	Detachment	6.68%
3	Dimensional thinking	10.06%	Synthesis	6.46%
4	Religion	7.55%	Cognition	6.25%
5	Country of origin	7.33%	Associate and communicate	6.23%
6	Culture	6.62%	Awareness	6.23%
7	Uniqueness	5.76%	Similarity	5.85%
8	Family	5.69%	External motivation	5.01%
9	Challenging the status quo	4.33%	Sensitivity	4.76%
10	***	***	Experiment and combine	4.04%
11	***	***	Dimensional thinking	4.01%
12	***	***	Problem-solving	2.93%
Cumulative variance explained (%)		73.59%		66.18%

Note: *** Not identified

Closer comparative analyses of the factors were done to identify:

- ◆ Pure factors are factors that appear in both conceptual frameworks and showed a large similarity on the questionnaire statements regarding these factors.
- ◆ Common factors which are factors that appear to be common to both conceptual frameworks but the questionnaire statements are not largely similar.

- ◆ Study specific factors which are factors that are unique to a specific conceptual framework.

6.2. Pure factors. There were no pure factors that could be directly compared.

6.3. Common factors. There are four common factors between the frameworks. The comparative analyses of these factors are shown in Figures 3 to 6. Figure 3 shows the variance explained by the factor cognition and communication.

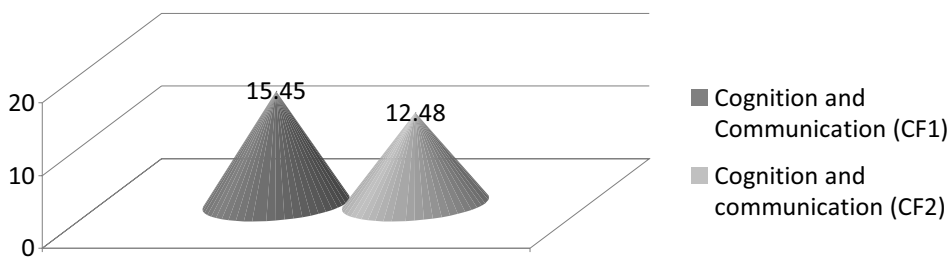

Fig. 3. Cognition and communication

This factor's variance in the conceptual framework to measure creativity at a general level (CF1) is 15.45%. This factor also appears in the conceptual framework for tertiary education (CF2) and shows a variance of 6.25% for cognition specifically and 6.23% for communication (12.48% in total). A cumulative variance difference of 3.1% can be

observed. Four questionnaire items in the amended questionnaires correspond, but four questionnaire items differ in CF1 and four questionnaire items in CF2. Communication and cognition is therefore a common factor and not a pure factor.

Figure 4 shows the variance explained by the factor problem-solving.

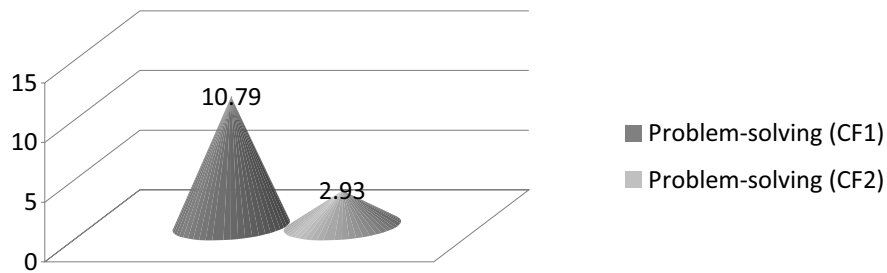

Fig. 4. Problem-solving

This factor’s variance in the conceptual framework to measure creativity at a general level (CF1) is 10.8%. This factor also appears in the conceptual framework for tertiary education (CF2) and shows a much lower variance of 2.9%. A cumulative variance difference of 7.9% can be observed. No questionnaire items in the amended questionnaires

correspond. Five questionnaire items appear in CF1 and one questionnaire item in CF2 which differ from one another. *Problem-solving* is therefore a common factor and not a pure factor.

Figure 5 shows the variance explained by the factor dimensional thinking.

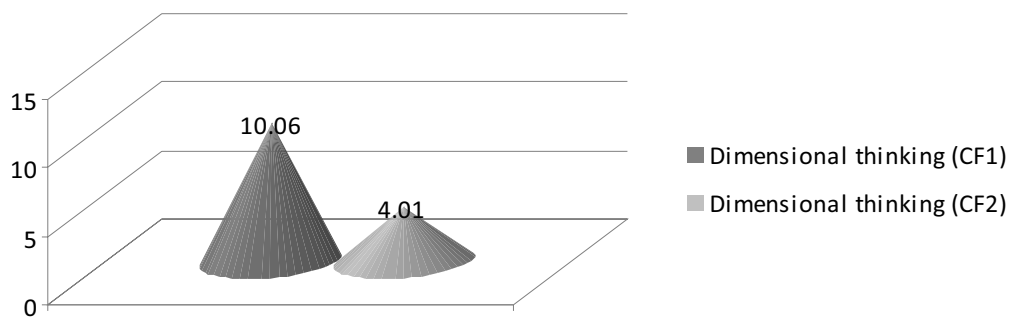

Fig. 5. Dimensional thinking

This factor’s variance in the conceptual framework to measure creativity at a general level is 10%. This factor also appears in the conceptual framework for tertiary education and shows a much lower variance of 4%. A cumulative variance difference of 6% can be observed. No questionnaire items in the amended questionnaires correspond. Four questionnaire items

appear in CF1 and two questionnaire items in CF2 which differ from one another. Dimensional thinking is therefore a common factor and not a pure factor.

Figure 6 shows the variance explained by the factor challenging the status quo.

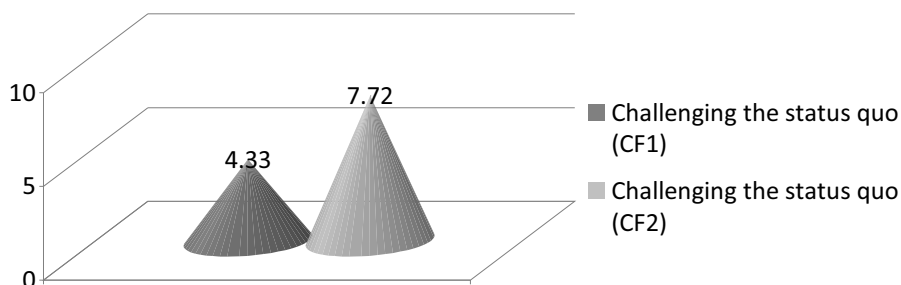

Fig. 6. Challenging the status quo

This factor’s variance in the conceptual framework to measure creativity at a general level is 4%. This factor also appears in the conceptual framework for tertiary education and shows a much higher variance of 8%. A cumulative variance difference

of 4% can be observed. No questionnaire items in the amended questionnaires correspond. One questionnaire item appear in CF1 and five questionnaire items in CF2 which differ from one another. Challenging the status quo is therefore a

common factor and not a pure factor. Table 2 shows the different factors as identified by each conceptual framework. There are no pure factors identified by this comparative study thus far. Only

four factors are common factors. Pearson correlation coefficient was used to compare the four common factors and the results are shown in Table 3 below.

Table 3. Pearson correlation coefficients between common factors

Factors	Cognition & communication		Problem-solving		Dimensional thinking		Challenging the status quo	
	CF1	CF2	CF1	CF2	CF1	CF2	CF1	CF2
Frameworks								
Factor loadings	0.82	0.769	0.785	0.882	0.834	0.749	0.701	0.729
	0.814	0.728	0.778		0.834	0.662	-0.572	0.729
	0.76	0.715	0.768		0.755			0.674
	0.697	0.724	0.56		0.628			0.546
	0.68	0.636	0.491					0.528
	0.678	0.622						
	0.611	0.526						
	0.577	0.46						
<i>r</i>	0.927		no value		no value		no value	

From the table above, it is clear that only one of the common factors between CF1 and CF2 could be tested statistically for correlation due to dissimilarities within these factors. The factor Cognition and Communication shows a strong positive correlation of almost 0.93 between the two frameworks.

6.4. Cumulative variance explained by the factors and Goodness of fit measures. From Table 2, it is evident that the conceptual framework to measure creativity at a general level (CF1) explains the most variance (almost 74%), while the conceptual framework to measure creativity at tertiary educational level (CF2) explained 66%.

It is important to note that the conceptual framework to measure creativity at a general level (CF1) is able to declare almost 74% of the variance by the factors that can be used to measure creativity. Resultantly, only 26% variance could not be explained to measure creativity. The conceptual framework to measure creativity at tertiary educational level (CF2) was able to declare 66% of variance by the factors that are used to measure creativity. Resultantly, 34% of variance cannot be explained by the factors. This comparison refers to the goodness-of-fit of the study and the data for both conceptual

frameworks has a cumulative variance of more than 60% which is regarded to be satisfactory (Hair et al. in Haasbroek, 2008, p. 53; Field, 2007, p. 634; Field, 2002, p. 7). Therefore, in this regard, the goodness-of-fit of the factor analysis of the conceptual framework to measure creativity at general level (CF1) is regarded to be good (74%), while the conceptual framework to measure creativity at tertiary educational level (CF2) is satisfactory (66%). There is only 8% difference between cumulative variance which strengthens the view of goodness-of-fit. Although both the frameworks exceed the required 60% goodness of fit measure with ease, CF1 clearly explains much more variance, and is, therefore, a better choice based on this criterion.

6.5. Points of inflection of factors. The point of inflection displays the distribution of variance explained by the factors, thus the more variance explained by the first factors could prove beneficial as the variance explained are more localized and less complicated to measure. The point of inflection is where the next factor explains almost the same variance as the one before, thus the marginal difference becomes negligible.

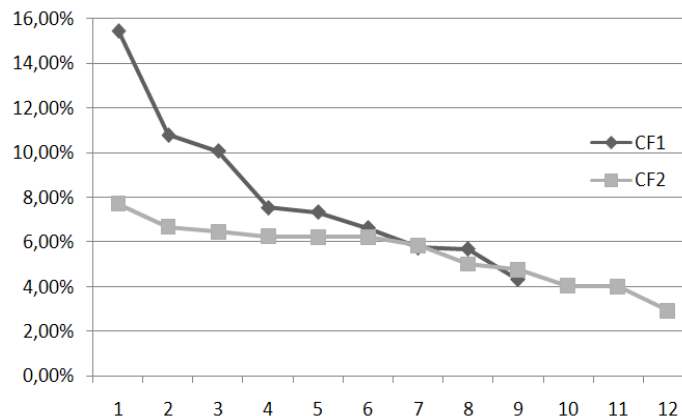

Fig. 7. Point of inflection

The analysis of the variance explained via the point of inflection shows that neither variance patterns reach the point of inflection. This means that none of the factors could be omitted from the analysis. CF1 explains much more of its variance at an early stage than CF2 does. In this regard,

CF1 is a more suitable choice as measuring framework.

6.6. Reliability of the factors. Table 4 below compares the reliability of the factors identified in the two conceptual frameworks. Cronbach Alpha was used to determine the reliability of each factor.

Table 4. Reliability of factors in the two conceptual frameworks

Conceptual framework (CF1)			Conceptual framework (CF2)		
Factor		Cronbach alpha	Factor		Cronbach alpha
1	Cognition and communication	0.858	1	Challenging the status quo	0.753
2	Problem-solving	0.635	2	Separate	0.741
3	Dimensional thinking	0.828	3	Synthesis	0.737
4	Religion	0.853	4	Cognition	0.768
5	Country of origin	0.740	5	Associate and communication	0.755
6	Culture	0.788	6	Awareness	0.735
7	Uniqueness	0.572	7	Similarity	0.737
8	Family	-1.071	8	External motivation	0.625
9	Challenging the status quo	-0.313	9	Sensitivity	0.751
			10	Experiment and combine	0.559
			11	Dimensional thinking	0.597
			12	Problem-solving	***

Note: *** Not identified

Factors 1, 3, and 4-6 (in CF1) and Factors 1-7, and 9 (in CF2) have satisfactory reliability coefficients in excess of the required 0.70 (Field, 2007, p. 666; George & Mallery, 2003, p. 231). Factor 2 (in CF1) and Factor 8 and 11 (in CF2) is below the set reliability coefficient of 0.70 as set by Field (2007, p. 666), but above the lower limit of 0.57 set by Cortina (Field, 2007, p. 666) with an acceptable reliability coefficient of 0.64, 0.63 and 0.60, respectively. Factor 7 (in CF1) and Factor 10 (in CF2) is marginally lower than Cortina with an acceptable reliability coefficient of 0.57 and 0.56 respectively. Schmitt (1996, p. 350) indicates that satisfactory levels of relatively low (e.g. 0.50) does not seriously reduce reliability as it depends on the test use and the interpretation, and as such, these marginal factors are retained for comparative reasons. Factor 8 and 9 (in CF1) show a negative reliability coefficient and the data regarding these

two factors is regarded as unreliable. There were no negative reliability coefficients in CF2. These two factors are thus omitted as they are less likely to present themselves in repeat studies.

This means that CF1 in reality consists of 7 and not 9 factors, and thus explains a reliable variance of 63.57% and not 73.59%. However, the fact remains that this variance still exceeds the required 60% goodness of fit measure, and does so with only 7 factors. In comparison, CF2 employs 12 reliable factors to explain 66.18% of the variance. Taking the number of factors in account, CF1 proves to be a better measuring framework, even with 2 unreliable and discarded factors.

6.7. KMO and Bartlett tests. Table 5 below compares the KMO and Bartlett tests of the two conceptual frameworks.

Table 5. Comparison of KMO and Bartlett tests

Applied test	Conceptual framework (CF1)	Conceptual framework (CF2)
Kaiser-Meyer-Olkin Measure of Sample Adequacy	.751	.820
Bartlett's Test of Approx. Chi-Square Sphericity	3203.071	3859.429
Df	465	741
Significance	.000	.000

Table 5 shows favorable Kaiser, Meyer and Ohlin (KMO) and that both conceptual frameworks had acceptable values higher than 0.70 (Field, 2007, p. 666). CF1 had a value of 0.75 and CF2 had a value of 0.82. The favorable KMO indicated that the sample used was adequate in CF1 and CF2. The

sample used in CF2 was, therefore, slightly more adequate (difference of 0.07) than the sample used in CF1. The Bartlett's Test of sphericity for both conceptual frameworks indicated that a factor analysis could be used for the data obtained as it remains below the 0.005 level (Field, 2002, p. 431).

CF1 had an approximate Chi-Square of 3202.071, the degrees of freedom (df) was 465 and significance (Sig.) was 000. CF2 had an approximate Chi-Square of 3859.429, the degrees of freedom (df) was 741 and significance (Sig.) was 000. The suitability for multivariate statistical analysis such as factor analysis for both CF1 and CF2 are suitable as both their

Bartlett tests show values below 0.005. Based on this comparison, both frameworks are highly acceptable, and no choice can be made between them.

6.8. Selection of conceptual framework. The results from the comparative analysis is summarized in the table below.

Table 6. Summary of comparative results

Criteria	CF1	CF2	Selected CF
Cumulative variance explained	73.59%	66.18%	CF1
Point of inflection	Steep curve	Flat curve	CF1
Number of factors	9	12	CF1
Reliability (Variance explained after omitting unreliable factors)	7 63.57%	12 66.18%	CF2
Number of factors to measure	7	12	CF1
KMO	Acceptable	Acceptable	No preference
Bartlett	Acceptable	Acceptable	No preference

Table 6 shows that although both conceptual frameworks performed well and could be employed to measure creativity in the tertiary education environment, CF1 is the better choice to do so.

Conclusions

From the analysis it can be concluded that:

1. This article focused on a comparative analysis of the two conceptual frameworks to measure creativity that was developed in the previous articles. The aim was to determine how strong the identified factors of these conceptual frameworks correlate and to determine how much these conceptual frameworks differ from one another. The primary objective was to identify the most reliable and valid conceptual framework to measure creativity at tertiary educational level.
2. A comparative factor analysis was done on the measuring instruments (CF1 and CF2) based on the % variance explained by each factor and the cumulative variance explained was compared. CF1 had less factors but explained the most variance (almost 74%), while CF2 explained 66% of the variance. CF1 therefore has a better 'good fit' than (CF2) as it explains more variance with less factors. CF2 however has a satisfactory 'goodness of fit'. The difference between the cumulative variance explained in CF1 and CF2 is 8%.
3. A closer comparative analysis indicated that there were no pure factors between CF1 and CF2. There were however four common factors – *cognition and communication, problem-solving, dimensional thinking and challenging the status quo*. The factor *cognition and communication* was the only factor that had questionnaire items that corresponded. The variance of cognition

and communication was slightly higher in CF1 (15.5%) than CF2 (12.4%) and the cumulative variance difference was 3.1%. No questionnaire items corresponded in terms of problem-solving, dimensional thinking and challenging the status quo and the variances differed much more. The variance of *problem-solving* was higher in CF1 (10.8%) than CF2 (2.9%) and the cumulative variance difference was 7.9%. The variance of *dimensional thinking* was higher in CF1 (10%) than CF2 (4%) and the cumulative variance difference was 6%. The variance of *challenging the status quo* was higher in CF2 (8%) than CF1 (4%) and the cumulative variance difference was 4%.

4. Only one of the common factors between CF1 and CF2 could be tested for Pearson's correlation. The factor *Cognition and Communication* shows a strong positive correlation of almost 0.93 between the two frameworks.
5. Five specific factors were identified in CF1 that do not appear in CF2 and explain a cumulative variance of 32.95%. These factors are *religion, country of origin, culture, uniqueness and family*.
6. Seven specific factors were identified in CF2 that do not appear in CF1 and explain a cumulative variance of 30.03%. These factors are separate, synthesis, awareness, similarity, external motivation, sensitivity and experiment and combine.
7. The Kaiser, Meyer and Ohlin (KMO) indicated that the sample was adequate in CF1 and CF2. Both conceptual frameworks had acceptable values higher than 0.70. CF1 had a value of 0.751 and CF2 had a value of 0.820.
8. The Bartlett's Test of sphericity for both conceptual frameworks indicated that a factor analysis could be used for the data obtained. CF1 had an approximate Chi-Square of

3202.071, the degrees of freedom (df) was 465 and significance (Sig.) was 000. CF2 had an approximate Chi-Square of 3859.429, the degrees of freedom (df) was 741 and significance (Sig.) was 000. CF2 was therefore slightly more suitable than CF1 for a factor analysis (difference of 656.358).

9. The Cronbach Coefficient Alpha was used to test the reliability of the factors and the reliability for both conceptual frameworks was good. All the factors in CF2 had satisfactory reliability coefficients. In CF1, Factor 8 (Family) and 9 (Challenging the status quo) showed a negative reliability coefficient and the data regarding these two factors is regarded as unreliable.
10. It was concluded that both conceptual frameworks are different in their own right. Both conceptual frameworks showed a good fit. CF1 however was viewed as having a better 'good fit' than (CF2) as it explains more variance with less factors. Both conceptual frameworks are reliable, unbiased and correlate only with their own factors. CF2 however was viewed as slightly more reliable than CF1 due to the fact that no negative reliability coefficients were identified for the factors.
11. The paper provided two newly created conceptual frameworks to measure creativity which can be developed into specific tests in various domains. These frameworks can be used to address the development of creative potential, assist in the designing and introduction of creativity education and creative skills development.

Summary

A comparative analysis was used in this paper to compare two conceptual frameworks in terms of the

factors identified in each, to determine if these factors are pure, common or specific factors, to determine how strong the identified factors, mentioned above, correlate and to determine how much these conceptual frameworks differ from one another. The aim was to determine the variance and the reliability of these factors and to determine the 'goodness of fit' of the respective conceptual frameworks.

Based on the comparative analysis it was concluded that both conceptual frameworks are different in their own right. It is evident therefore that it remains a challenge to identify a standardized measure to measure creativity due to the various combinations of personal characteristics, cognitive processes and environmental settings needed to measure creativity at a general and tertiary educational level. The comparative study also indicated that the basic resources needed for creative thought, as identified by the confluence approach, are also evident in the two conceptual frameworks, although not all of these resources appear in each conceptual framework specifically. CF1 included external factors that influence creative potential and CF2 focused more on cognitive and thinking processes which are necessary at tertiary educational level. CF1 has a better 'good fit' than CF2 as it explains more variance with less factors. Both conceptual frameworks are reliable, unbiased and correlate only with their own factors. CF2 however was viewed as slightly more reliable than CF1 due to the fact that no negative reliability coefficients were identified for the factors. It can therefore be concluded that CF2 has more merit to measure creativity at tertiary educational due to its focus on cognitive and thinking processes required at tertiary educational level.

References

1. Albright, J.J. & Myoung Park, H. (2009). Confirmatory factor analysis using Amos, LISREL, Mplus, SAS/STAT CALIS. Indiana University: University Information Technology Services. Retrieved from the World Wide Web: <http://www.indiana.edu/>, Accessed 15 April 2012.
2. Allen, K.R. (2012). *New Venture Creation*, Sixth Edition, Mason: South Western Cengage Learning.
3. Bama, A. (2014). Retrieved from the World Wide Web: <http://www.bama.ua.edu/~jcsenkbeil/gy523/Factor%20Analysis.pdf>, Accessed 25 May 2014.
4. Barringer, B.R. & Ireland, R.D. (2010). *Entrepreneurship: successfully launching new ventures*, Third Edition, Upper Saddle River, New Jersey: Pearson Education. Inc.
5. Bronson, P. & Merryman, A. (2010). *The creativity crisis*, Newsweek, 21-25, 19 Jul.
6. Cortina J. (1993). What is coefficient alpha: an examination of theory and applications, *Journal of applied psychology*, 78, pp. 98-104.
7. Cropley, D.H. (2008). Fostering and measuring creativity and innovation: individuals, organisations and products, *Mendeley Issue*, 1942, pp. 267-278.
8. De Coster, J. (1998). Overview of factor analysis. Retrieved from the World Wide Web: <http://www.stat-help.com/notes.html>, Accessed 15 April 2012.
9. Du Plessis, J.L. (2010). *Statistical consultation services*, Department of Statistics, Potchefstroom, North-West University.
10. Field, A. (2002). *Discovering statistics using SPSS*, Second Edition, London: Sage.

11. Field, A. (2007). *Discovering statistics using SPSS*, Second Edition, London: Sage.
12. Fields, Z. & Bisschoff, C.A. (2013a). A model to measure creativity in young adults, *Journal of Social Sciences*, 37 (1), pp. 55-67.
13. Fields, Z. & Bisschoff, C.A. (2013b). A theoretical model to measure creativity at a University, *Journal of Social Sciences*, 34 (1), pp. 47-59.
14. Groenewald, D. (2013). *Contemporary management aspects*, Cape Town, Juta and company Ltd.
15. Haasbroek, A. (2008). *Brand positioning in the remarketing automotive industry*, MBA Dissertation, Potchefstroom, North-West University.
16. Hafiz, B. & Shaari, J.A.N. (2013). Confirmatory factor analysis (CFA) of first order factor measurement model-ICT empowerment in Nigeria, *International Journal of Business Management and Administration*, 2 (5), pp. 81-88.
17. Harrington, B. (2008). Confirmatory factor analysis. Statistics Solutions. Retrieved from the World Wide Web: <http://www.statisticssolutions.com/methods-chapter/statistical-tests/confirmatory-factor-analysis/>, Accessed 15 April 2012.
18. Lau, K.W., Ng, M.C.F. & Lee, P.Y. (2009). Rethinking the creativity training in design education: a study of creative-thinking tools for facilitation creativity development of design students, *Art, Design & Communication in Higher Education*, 8 (1), pp. 71-84.
19. Pett, M.A., Lackey, N.R. & Sullivan, J.J. (2003). Making sense of factor analysis: an overview of factor analysis. Sage research methods online. Retrieved from the World Wide Web: <http://srmo.sagepub.com/view/making-sense-of-factor-analysis/n1.xml>, Accessed 15 April 2012.
20. Rasool, F. (2011). *The role of skills immigration in addressing skills shortages in South Africa*, (Thesis - PhD), Potchefstroom, North-West University.
21. Schmitt, M. (1996). Uses and abuses of coefficient alpha, *Psychological Assessment*, 8 (4), pp. 350-353.
22. Schönrock-Adema, J., Heijne-Penninga, M., Van Hell, E.A. & Cohen-Schotanus, J. (2009). Necessary steps in factor analysis: enhancing validation studies of educational instruments, *Medical Teacher*, 31 (6), pp. 226-232.
23. Schwarz, J. (2011). Research methodology: tools. Lucerne University of Applied Sciences and Arts. Retrieved from the World Wide Web: http://www.schwarzpartners.ch/Applied_Data_Analysis/Lect%2004_EN.pdf, Accessed 15 April 2012.
24. Suhr, D.D. (No date). Exploratory or confirmatory factor analysis. Retrieved from the World Wide Web: <http://www2.sas.com/proceedings/sugi31/200-31.pdf>, Accessed 15 April 2012.
25. Tavakol, M. & Dennick, R. (2011). Making sense of Cronback Alpha, *International Journal of Medical Education*, 2, pp. 53-55.
26. Wuensch, K.L. (2009). Factor analysis with SPSS. Retrieved from the World Wide Web: <http://www.core.ecu.edu/psyc/wuenschk/MV/FA/FA-SAS.ppt>, Accessed 15 April 2012.
27. Zikmund, W.G. (2008). *Business research methods*, Seventh Edition, London, Thomson Learning.